

2024

SONNENSCHIRME
PARASOLS



INHALT | CONTENTS

05 MARKE Knirps | Knirps BRAND

07 SAVE - REPAIR - CARE

09 Knirps PHOENIX

10 Übersicht PHOENIX | Overview PHOENIX

12 Knirps PHOENIX 315

14 Knirps PHOENIX 245 x 245

16 Zubehör PHOENIX | PHOENIX add-ons

19 Knirps APOLL

20 Übersicht APOLL | Overview APOLL

22 Knirps APOLL 240 x 240 **BLACK EDITION**

24 Knirps APOLL 290

26 Knirps APOLL 240 x 240

28 Knirps APOLL 260 x 165

30 Knirps APOLL 230 x 150

32 Zubehör Mittelmastschirme | Apoll add-ons

35 Knirps PENDULAR

36 Übersicht PENDULAR | Overview PENDULAR

38 Knirps PENDULAR 320 x 320

40 Knirps PENDULAR 275 x 275

42 Knirps PENDULAR 340

44 Zubehör PENDULAR | PENDULAR add-ons

46 POINT OF SALE

48 Knirps POINT OF SALE

50 POINT OF SALE Konzepte | POINT OF SALE Concepts

52 ERKLÄRUNG SYMBOLE | EXPLANATION OF SYMBOLS

54 Schatten zu jeder Tageszeit | Shade at any time of day





Schirmfarben von Imagebildern können wegen Lichteinstrahlung abweichen.
Canopy colors of image pictures can deviate due to light irradiation.



FÜR JEDES WETTER

Knirps, die Marke mit dem roten Punkt, erfand 1928 den ersten faltbaren Regenschirm und ist heute weltweit bekannt und bietet innovative Ideen, auf Funktion ausgerichtete, stilvolle Designs. Knirps steht weltweit für German Engineering und ist ein Qualitätsversprechen, auf das sich unsere Kunden bei jedem Wetter verlassen können. Wir bieten eleganten Wetterschutz vom Regenschirm bis hin zum Sonnenschirm.

Performance, Stil und Komfort: unsere Kriterien für jeden Knirps Sonnenschirm.

FOR ANY WEATHER

Knirps, the brand with the red dot, invented the first foldable umbrella in 1928 and is now globally recognized for offering innovative, function-oriented, and stylish designs. Knirps is synonymous with German engineering worldwide, and is a quality promise our customers can rely on in any weather. We provide elegant weather protection from rain umbrellas to parasols.

Performance, style, and comfort: our criteria for every Knirps parasol.





SAVE - REPAIR - CARE

Seit über 95 Jahren ist die Qualität unserer Produkte der Inbegriff von Knirps. In unserem Sinne verbinden wir Langlebigkeit mit Nachhaltigkeit, geben auf alle Produkte fünf Jahre Garantie und bieten für unsere Produkte einen umfassenden Zyklus:

For over 95 years, the quality of our products has been the epitome of Knirps. In line with our values, we combine longevity with sustainability, provide a five-year warranty on all products, and offer a comprehensive cycle for our products:

SAVE

Eine Umwelt schonende Auswahl und Zusammenstellung exklusiver Materialien, technische Raffinessen und das zeitlose Design machen unsere Produkte zum modernen Wetterschutzexperten und langjährigem Partner bei jedem Wetter.

An environmentally friendly selection and composition of exclusive materials, technical refinements, and timeless design make our products modern weather protection experts and long-term partners in any weather.

REPAIR

Um unseren Planeten zu bewahren, möchten wir Sie bei Bedarf zur Reparatur ermutigen. Unseren fachkundigen Werkstätten reparieren liebevoll auch Jahrzehnte alte Knirps Produkte.

To preserve our planet, we encourage you to have your Knirps repaired, when necessary. Our expert workshops lovingly repair Knirps products that are decades old.

CARE

Wir lassen unsere Produkte und unsere Produktionsstätten von externen, zertifizierten Instituten u.a. BSCI auf soziale Standards und Qualität prüfen. Gemeinsam können wir durch einen verantwortungsvollen Umgang mit all unseren Ressourcen und entsprechendem Konsumverhalten einen positiven Beitrag zum Umweltschutz leisten.

We have our products and production facilities tested by external certified institutions such as BSCI for social standards and quality. Together, we can make a positive contribution to environmental protection through responsible use of all our resources and appropriate consumption behavior.

Schirmfarben von Imagebildern können wegen Lichteinstrahlung abweichen.
Canopy colors of image pictures can deviate due to light irradiation.

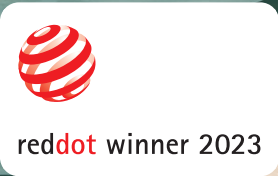



PATENTIERTE **WELTNEUHEIT**
PATENTED **WORLD INNOVATION**

Knirps **PHOENIX**

DIE SCHIRM-INNOVATION für Ihre Terrasse!

Knirps stellt mit dem **Knirps Phoenix** einen innovativen Sonnenschirm für die Terrasse vor. Das puristische Schirmdesign aus robustem Aluminium lässt sich einfach und stilvoll im passenden Sockel arretieren - ohne sich zu bücken oder zu schrauben. Das patentierte **Knirps Easy Click®**-Konzept ermöglicht es, den Schirm mit nur einem Klick auf den Fußtaster aufzustellen. Dank vier leichtläufiger Rollen lässt sich der Schirm einfach an jede Position der Terrasse rollen. Das Schirmdach lässt sich mühelos, durch das patentierte **Easy Lift®** System, an jeden Sonnenstand anpassen. Die Produkte sind sorgfältig ausgewählt, teils recycelten Materialkombinationen hergestellt und erfüllen höchste Ansprüche an Qualität, Design und **Nachhaltigkeit**. Mit **5 Jahren Garantie** ist der Knirps Phoenix eine nachhaltige Lösung für die Terrassengestaltung.

THE PARASOL INNOVATION for your terrace!

Knirps introduces the **Knirps Phoenix**, an innovative parasol for your terrace. The minimalist parasol design made of robust aluminum can be easily and stylishly locked into the matching base without bending down or screwing. The patented **Knirps Easy Click®** concept allows the parasol to be set up with just one click on the foot pedal. Thanks to four smooth-running wheels, the parasol can be easily moved to any position on the terrace. The parasol canopy can be effortlessly adjusted to any angle of the sun thanks to the patented **Easy Lift®** system. The products are made from carefully selected, partly recycled combination of materials, meeting the highest standards of quality, design, and **sustainability**. With a **5-year guarantee**, the Knirps Phoenix is a sustainable solution for terrace design.

Schirmfarben von Imagebildern können wegen Lichteinstrahlung abweichen.
Canopy colors of image pictures can deviate due to light irradiation.

OVERVIEW PHOENIX



VERSCHLUSSBAND CLOSURE STRAP

Edles Verschlussband
mit Knirps-Metallemblem
Elegant closure strap with
Knirps metal emblem

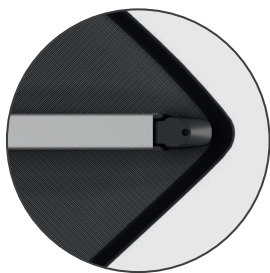

ABNEHMBARER BEZUG REMOVABLE COVER

selbstspannende Spitzen
self-tensioning tips



rPET-BEZUG rPET CANOPY

Spinndüsen gefärbeter, recycelter
und PFC freier Stoff mit UV 80 sowie
Lichtechtheit 7; kontrastfarbenes
Einfassband

Spun-dyed, recycled, and PFC-free
fabric with UV 80 and lightfastness 7;
contrast-colored edging

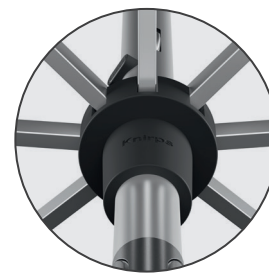

GESTELL FRAME

Robustes, korrosions-
beständiges Gestell aus elo-
xiertem Aluminium
Durable, corrosion-resistant
frame made of anodized alu-
minium



Knirps EASY-LIFT®

Durch Lösen des Drehrads lässt sich der Schirm bis zu 15 cm in der Höhe verstellen. Die Gasdruckfeder macht dies zum Kinderspiel. In seiner Endposition muss der Schirm mittels Drehknopf arretiert werden. Bei tiefen Sonnenstand einfach den Schirm nach unten ziehen und wieder in der gewünschten Position arretieren.

By releasing the push button, the parasol can be adjusted in height up to 15 cm, made easy with the gas pressure spring. Once in the desired position, the parasol must be locked using the rotary knob. When the sun is low, simply pull the parasol down and lock it again in the desired position.

SCHIRMTOP PARASOL TOP

mit geprägtem Knirps Logo
with embossed Knirps logo



STOPPER

mit Knirps-Branding
with Knirps branding

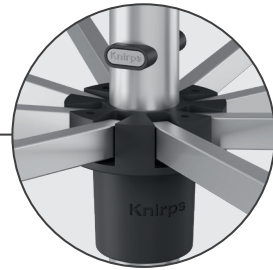

Knirps EASY TILT®

Mit der patentierten Knirps Easy Tilt® Funktion lässt sich das Schirmdach bis zu 30° Grad komfortabel und automatisch durch Drehen der Kurbel neigen. Der Griff an der leichtgängigen Kurbel kann eingeklappt werden.

The patented Knirps Easy Tilt® function allows for comfortable and automatic tilting of the parasol canopy up to 30° by turning the crank. The handle on the smooth-running crank can be folded down.

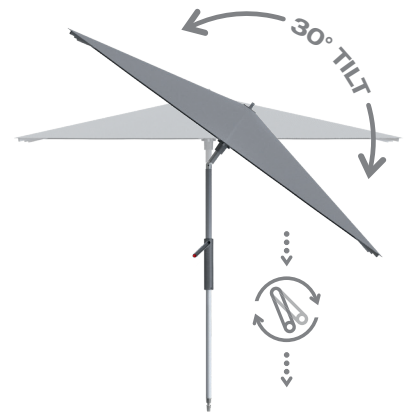

Knirps EASY-CLICK®

Stehender Auf- und Abbau des Schirms mit nur einem Fußtritt

One-foot operation for setting up and taking down the parasol while standing

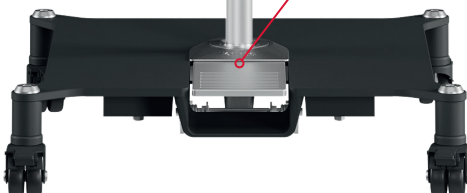
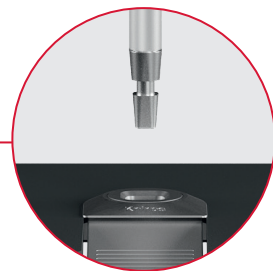



Schmalfarben von Imagebildern können wegen Lichteinstrahlung abweichen.
 Canopy colors of image pictures can deviate due to light irradiation.

- | | | | | | |
|---|---|---|---|--|--|
| 
5
YEARS
WARRANTY | 
315 cm | 
EASY TILT® | 
EASY LIFT® | 
EASY CLICK® | 
rPET |
| | 
PFC FREE | 
LIGHTFAST | 
220 g/m ² | 
TENSIONER | 
REMOVABLE |

Knirps PHOENIX 315



209
DARK GREY



809
LIGHT GREY



409
BORDEAUX



509
SAND



50kg

product design by
DESIGN BALLENDAT

Modell Model	Artikelnummer Item number	Größe Size	Schirmfläche Parasol size	Rohr Ø Rod Ø	Verpackung Packaging	Gewicht Weight
Phoenix 315/8	9011315 + Col.Nr.	315 cm	ca. 7,6 m ²	42 / 38 mm	213 × 16 × 16 cm	8,3 kg
Protector Schutzhülle	85399KNPHAP	50 × 215 cm			42 × 21 × 3,5 cm	0,8 kg

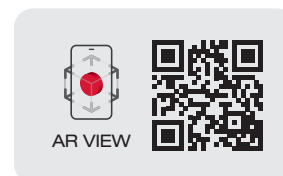
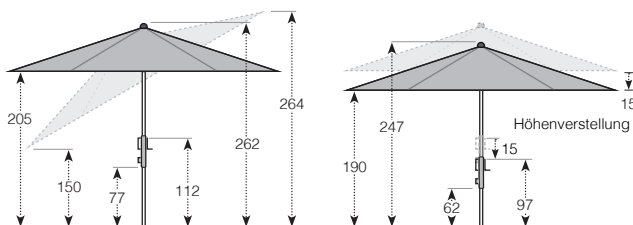

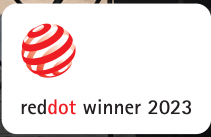

Schmitten von Imagebildern können wegen Lichteinstrahlung abweichen.
Canopy colors of image pictures can deviate due to light irradiation.

- | | | | | | |
|--|---------------------|-------------------|----------------------------|--------------------|------------------|
| <p>5
YEARS
WARRANTY</p> | <p>245 x 245 cm</p> | <p>EASY TILT®</p> | <p>EASY LIFT®</p> | <p>EASY CLICK®</p> | <p>rPET</p> |
| <p>WARRANTY</p> | <p>PFC FREE</p> | <p>LIGHTFAST</p> | <p>220 g/m²</p> | <p>TENSIONER</p> | <p>REMOVABLE</p> |

Knirps PHOENIX 245 x 245



209
DARK GREY



809
LIGHT GREY



409
BORDEAUX



509
SAND



50kg



reddot winner 2023

product design by
DESIGN BALLENDAT

Modell Model	Artikelnummer Item number	Größe Size	Schirmfläche Parasol size	Rohr Ø Rod Ø	Verpackung Packaging	Gewicht Weight
Phoenix 245 x 245/8	9012245 + Col.Nr.	245 x 245 cm	ca. 6 m ²	42 / 38 mm	213 x 16 x 16 cm	6,8 kg
Protector Schutzhülle	85399KNPHAP	50 x 215 cm			42 x 21 x 3,5 cm	0,8 kg

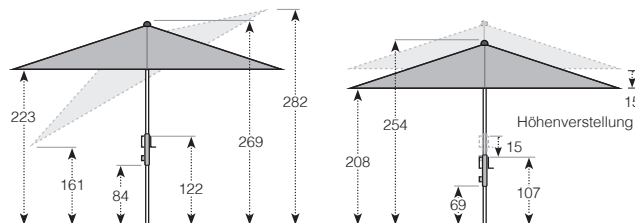

ADD-ONS PHOENIX

PATENTIERTE **WELTNEUHEIT**
PATENTED **WORLD INNOVATION**

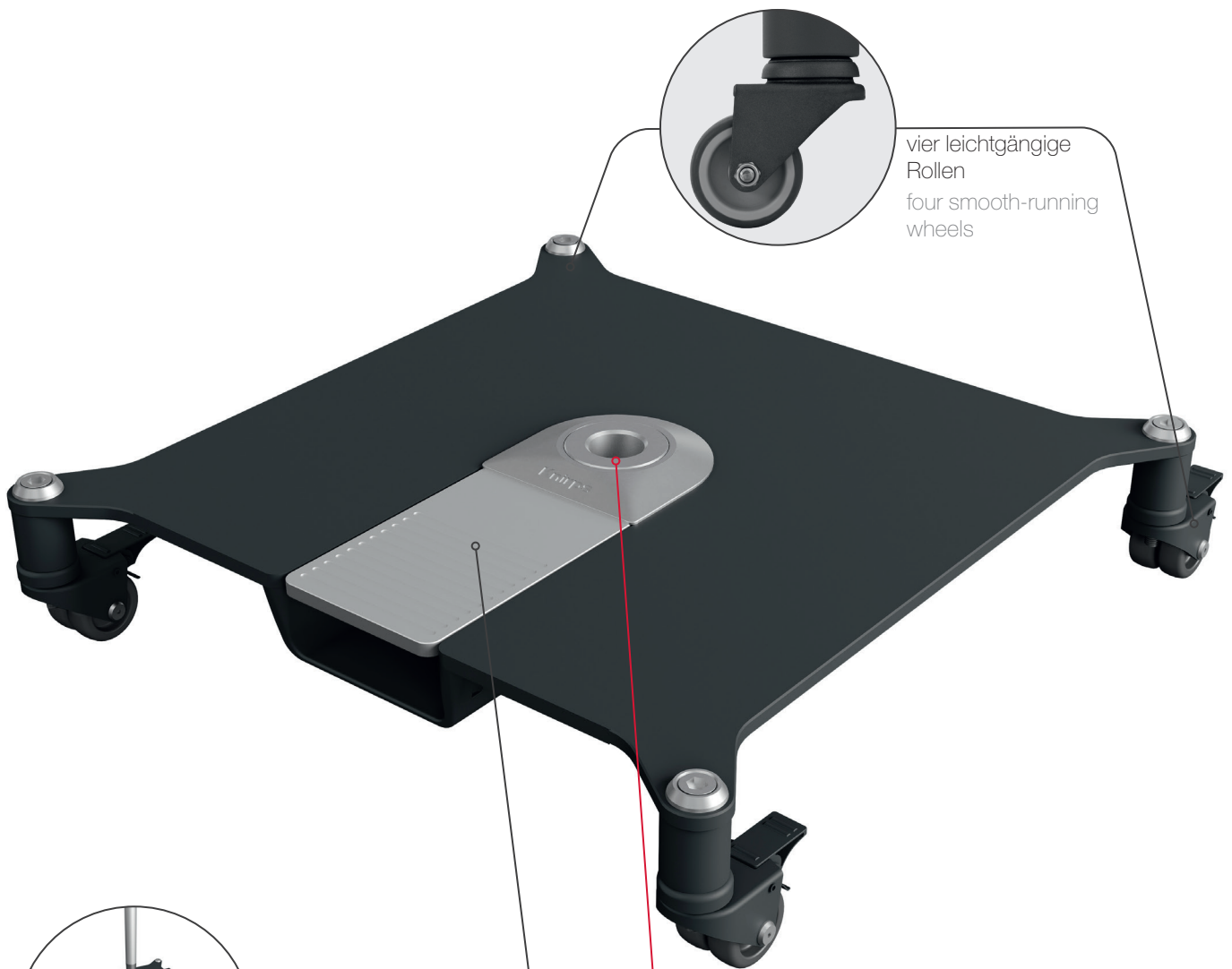

vier leichtgängige
Rollen
four smooth-running
wheels



Pedal zum Schirmauf- oder
-abbau
Pedal for parasol assembly
or disassembly

Knirps EASY-CLICK®

passend für alle Knirps Phoenix oder Knirps
Easy Click® Adapter
Compatible with all Knirps Phoenix or Knirps
Easy Click® Adapter models



reddot winner 2023

Knirps EASY-CLICK® SOCKEL

STAHL 50

Knirps EASY-CLICK® BASE

STEEL 50

Mit nur einem Fußtritt lässt sich der Schirm im Easy Click® Sockel auf- und abbauen. Geeignet für alle Knirps PHOENIX Modelle und Knirps Connector.

With just one footstep, you can assemble and disassemble your parasol from the Easy Click® base. Suitable for all Knirps PHOENIX models and the Knirps Connector.

Artikelnummer Item number	Größe Size	Verpackung Packaging	Gewicht Weight
85999KNPS50EASY	58 × 58 × 14 cm	66 × 66 × 18 cm	~50 kg



PROTECTOR

FÜR MITTELMASTSCHIRME

PROTECTOR

FOR CENTER POLE PARASOLS

Extra lange Schutzhülle für Mittelmastschirme aus witterungsbeständigem Polyester mit praktischer Teleskopstange.

Extra-long protective cover for center pole parasols made of weather-resistant polyester with a practical telescopic pole.

Artikelnummer Item number	Größe Size	Verpackung Packaging	Gewicht Weight
85399KNPHAP	50 × 215 cm	42 × 21 × 3,5 cm	0,8 kg

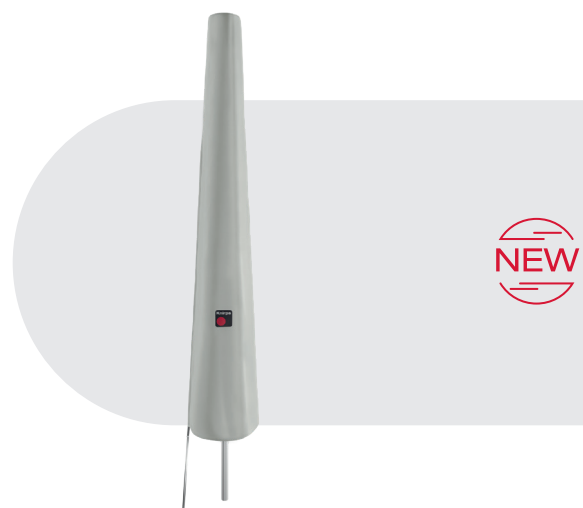





Schirmfarben von Imagebildern können wegen Lichteinstrahlung abweichen.
Canopy colors of image pictures can deviate due to light irradiation.

Knirps APOLL

Puristisches Design

Die prämierte Knirps Mittelmast Schirmserie wurde in Zusammenarbeit mit Design Ballendat kreiert. Mit ihrem exklusivem Look überzeugen Apoll Schirme durch zahlreiche funktionale Details wie z.B. **Knirps Easy Tilt®** und der praktischen Höhenverstellung. Mit dem innovativen **Knirps Easy Click® Adapter**, wird der zügige Auf- und Abbau des Sonnenschirms bei jedem Wetter zum Kinderspiel.

Umfangreiche Zubehörartikel, vier Größen und sechs Bezugsfarben bieten viele Möglichkeiten zur individuellen Gestaltung.

Die Knirps Apoll **Black Edition** mit schwarzem Schirmgestell gibt es in den Bezugsfarben Black und Light Grey in 240 x 240 cm.

Puristic Design

The award-winning Knirps center pole parasol series was created in collaboration with Design Ballendat. With its exclusive look, Apoll parasols impress with numerous functional details such as **Knirps Easy Tilt®** and practical height adjustment. With the innovative **Knirps Easy Click®** adapter, setting up and taking down the parasol quickly and easily becomes child's play, no matter what the weather conditions are like.

Extensive accessories, four sizes, and six cover colors offer many possibilities for individual design.

The Knirps Apoll **Black Edition** with a black parasol frame is available in black and light grey in 240 x 240 cm.

OVERVIEW APOLL



ABNEHMBARER BEZUG REMOVABLE COVER

selbstspannende Spitzen
self-tensioning tips

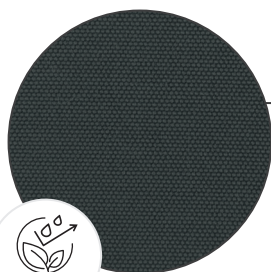

PFC FREIER BEZUG PFC-FREE COVER

mit UV 80 und Lichtechtheit 6-7
with UV 80 and lightfastness of 6-7

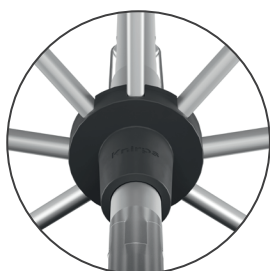

GESTELL FRAME

Korrosionsbeständiges Gestell
aus hochwertigem Aluminium
Corrosion-resistant frame made
of high-quality aluminum



HÖHEN-/TIEFENVERSTELLUNG HEIGHT/DEPTH ADJUSTMENT

Bis zu 30 cm kann das Schirmdach in seiner Höhe am Drehknopf des Mittelastes verstellt werden. Durch diese leicht zu bedienende Zusatzfunktion spendet Knirps Apoll zu jeder Tageszeit optimalen Schatten.

The parasol canopy can be adjusted in height by up to 30 cm using the knob on the center pole. With this additional easy-to-use function, the Knirps Apoll provides optimal shade at all times of the day.

**SCHIRMTOP
PARASOL TOP**

mit geprägtem Knirps Logo
with embossed Knirps logo



STOPPER

mit Knirps-Branding
with Knirps branding

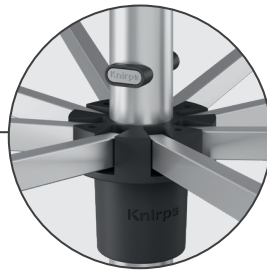

Knirps EASY TILT®

Mit der patentierten Knirps Easy Tilt® Funktion lässt sich das Schirmdach bis zu 30° Grad komfortabel und automatisch durch Drehen der Kurbel neigen.

With the patented Knirps Easy Tilt® function, the parasol canopy can be tilted comfortably and automatically up to 30° by turning the crank.

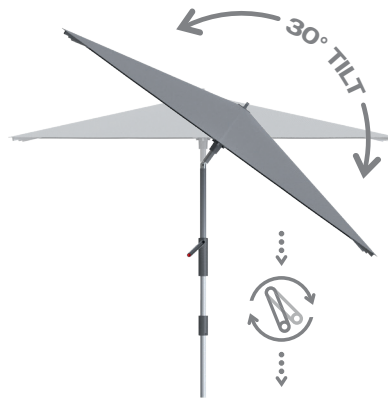

**KURBEL
CRANK**

Leichtgängige Kurbel mit abklappbarem Griff
Smooth crank with a foldable handle

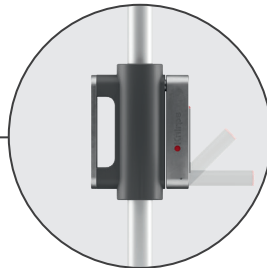



Schmalfarben von Imagebildern können wegen Lichteinstrahlung abweichen.
 Copy colors of image pictures can deviate due to light irradiation.

5
YEARS

WARRANTY



240x240 cm



EASY TILT®



30 cm



PFC FREE



LIGHTFAST



220 g/m²

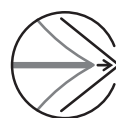

TENSIONER



REMOVABLE

Knirps APOLL 240 x 240 **BLACK EDITION**



110
BLACK



810
LIGHT GREY



BLACK EDITION

schwarzes Aluminiumgestell
black aluminium frame



50kg

product design by
DESIGN BALLENDAT

Modell Model	Artikelnummer Item number	Größe Size	Schirmfläche Parasol size	Rohr Ø Rod Ø	Verpackung Packaging	Gewicht Weight
Apoll 240 x 240/8	9022240 + Col.Nr.	240 x 240 cm	ca. 5,8 m ²	35 / 38 mm	213 x 16 x 16 cm	9,9 kg
Knirps Schutzhülle	85399KN	32 x 180 cm			27 x 29 x 3 cm	0,6 kg

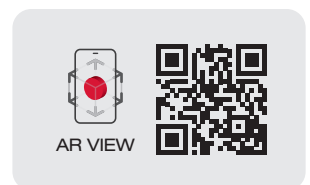
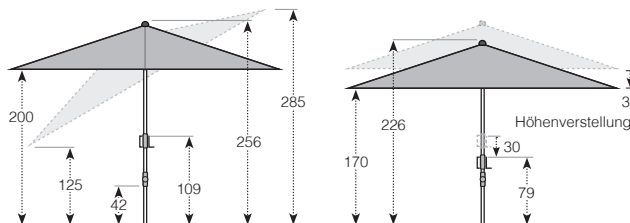



Schmalfarben von Imagebildern können wegen Lichteinstrahlung abweichen.
 Canopy colors of image pictures can deviate due to light irradiation.

5
YEARS

WARRANTY



290cm



EASY TILT®



30cm



PFC FREE



LIGHTFAST



220 g/m²



TENSIONER



REMOVABLE

Knirps APOLL 290



100
BLACK



200
DARK GREY



800
LIGHT GREY



400
BORDEAUX



500
SAND



900
NATURE



50kg

product design by
DESIGN BALLENDAT

Modell Model	Artikelnummer Item number	Größe Size	Schirmfläche Parasol size	Rohr Ø Rod Ø	Verpackung Packaging	Gewicht Weight
Apoll 290/6	9021290 + Col.Nr.	290 cm	ca. 6,6 m ²	35 / 38 mm	213 × 16 × 16 cm	8,1 kg
Knirps Schutzhülle	85399KN	32 × 180 cm			27 × 29 × 3 cm	0,6 kg

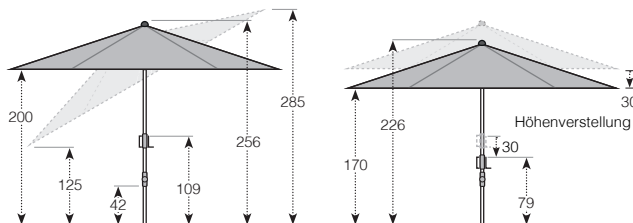



Schmalfarben von Imagebildern können wegen Lichteinstrahlung abweichen.
 Copy colors of image pictures can deviate due to light irradiation.

5
YEARS

WARRANTY



240 x 240 cm



EASY TILT®



30 cm



PFC FREE



LIGHTFAST



220 g/m²

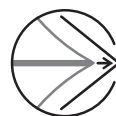

TENSIONER



REMOVABLE

Knirps APOLL 240 x 240



100
BLACK



200
DARK GREY



800
LIGHT GREY



400
BORDEAUX



500
SAND



900
NATURE



50kg



product design by
DESIGN BALLENDAT

Modell Model	Artikelnummer Item number	Größe Size	Schirmfläche Parasol size	Rohr Ø Rod Ø	Verpackung Packaging	Gewicht Weight
Apoll 240 x 240/8	9022240 + Col.Nr.	240 x 240 cm	ca. 5,8 m ²	35 / 38 mm	213 x 16 x 16 cm	9,9 kg
Knirps Schutzhülle	85399KN	32 x 180 cm			27 x 29 x 3 cm	0,6 kg

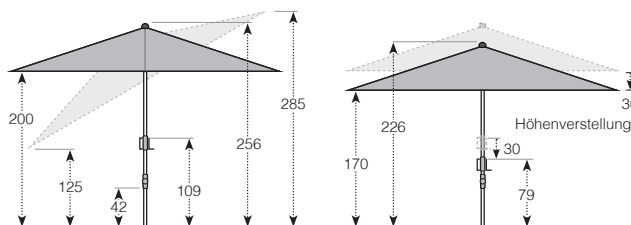



Schmalfarben von Imagebildern können wegen Lichteinstrahlung abweichen.
 Copy colors of image pictures can deviate due to light irradiation.

5
YEARS

WARRANTY



260 x 165 cm



EASY TILT®



30 cm



PFC FREE



LIGHTFAST



220 g/m²



TENSIONER



REMOVABLE

Knirps APOLL 260 x 165



100
BLACK



200
DARK GREY



800
LIGHT GREY



400
BORDEAUX



500
SAND



900
NATURE



50kg

product design by
DESIGN BALLENDAT

Modell Model	Artikelnummer Item number	Größe Size	Schirmfläche Parasol size	Rohr Ø Rod Ø	Verpackung Packaging	Gewicht Weight
Apoll 260 x 165/6	9023260 + Col.Nr.	260 x 165 cm	ca. 4,3 m ²	35 / 38 mm	213 x 16 x 16 cm	7,8 kg
Knirps Schutzhülle	85399KN	32 x 180 cm			27 x 29 x 3 cm	0,6 kg

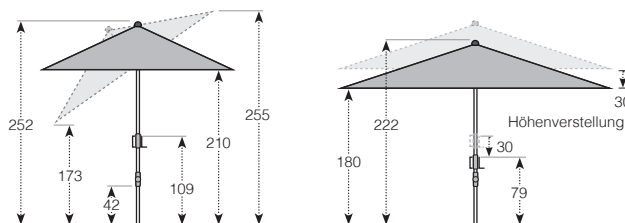



Schmalfarben von Imagebildern können wegen Lichteinstrahlung abweichen.
 Canopy colors of image pictures can deviate due to light irradiation.

5
YEARS

WARRANTY



230 x 150 cm



EASY TILT®



30 cm



PFC FREE



LIGHTFAST



220 g/m²

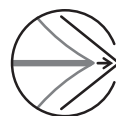

TENSIONER



REMOVABLE

Knirps APOLL 230 x 150



100
BLACK



200
DARK GREY



800
LIGHT GREY



400
BORDEAUX



500
SAND



900
NATURE



IDEAL FÜR
BALKONE
IDEAL FOR
BALCONIES



40kg



BALCONY



25kg

product design by
DESIGN BALLENDAT

Modell Model	Artikelnummer Item number	Größe Size	Schirmfläche Parasol size	Rohr Ø Rod Ø	Verpackung Packaging	Gewicht Weight
Apoll 230 x 150/6	9023230 + Col.Nr.	230 x 150 cm	ca. 3,45 m ²	35 / 38 mm	213 x 16 x 16 cm	7,1 kg
Knirps Schutzhülle	85399KN	32 x 180 cm			27 x 29 x 3 cm	0,6 kg

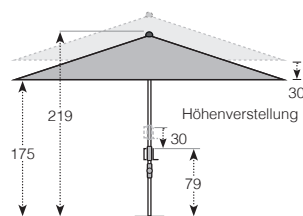
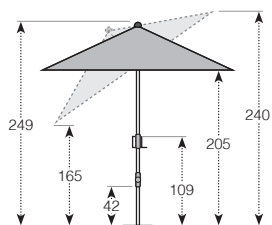

ADD-ONS APOLL



~ 40 kg



~ 50 kg

40 kg Variante kann von der Darstellung abweichen
40 kg version may differ from the image



TROLLEYSOCKEL

GRANIT 50 | GRANIT 40

TROLLEY BASE

GRANITE 50 | GRANITE 40

Edler Sockel mit praktischer Trolleyfunktion aus poliertem, dunklen Granit mit Edelstahlgriff und -standrohr, sowie zwei leichtläufigen Rollen.

Elegant base with practical trolley function made of dark, polished granite with stainless steel handle and standpipe, as well as two smooth-rolling wheels.

(Standrohr 60 mm, inkl. 4 Reduziereinsätze 32, 38, 48, 52 mm)

(Pole 60 mm, incl. 4 adapters in 32, 38, 48, 52 mm respectively)

Artikelnummer Item number	Größe Size	Verpackung Packaging	Gewicht Weight
85897KN40	48 x 48 x 7 cm	64 x 55 x 12 cm	~ 40 kg
85897KN50	55 x 54 x 7cm	70 x 62 x 12 cm	~ 50 kg



~ 50 kg

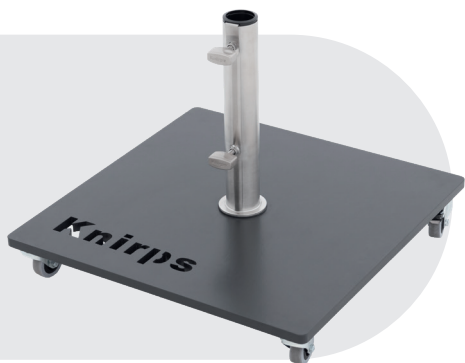

ROLLSOCKEL

STAHL 50

ROLLING BASE

STEEL 50

Sockel aus pulverbeschichtetem Stahl mit Edelstahlrohr und vier Rollen.

Base made of powder-coated steel with stainless steel tube and four wheels.

(Standrohr 48 mm, inkl. 3 Reduziereinsätze 25, 32, 38 mm)

(Pole 48 mm, incl. 3 adapters in 25, 32, 38 mm respectively)

Artikelnummer Item number	Größe Size	Verpackung Packaging	Gewicht Weight
85999KNPS50	50 x 50 x 8,5 cm	52 x 52 x 11 cm	~ 50 kg



Knirps EASY CLICK® CONNECTOR FÜR KNIRPS APOLL

Knirps EASY CLICK® CONNECTOR FOR KNIRPS APOLL

Das Unterrohr Easy Click® Connector passt für alle Knirps Apoll Modelle. Damit lässt sich jeder Knirps Apoll mit nur einem Fusstritt in den Easy Click® Sockel auf- und abbauen. Passender Sockel Knirps Easy Click® auf Seite 17. Rohrdurchmesser 38mm

The Easy Click® Connector lower tube fits all Knirps Apoll models. This allows for easy assembly and disassembly of any Knirps Apoll with just one footstep onto the Easy Click® base. Matching base Knirps Easy Click® on page 17. Tube diameter is 38mm.

Artikelnummer Item number	Größe Size	Verpackung Packaging	Gewicht Weight
78099KEASYAP	8,2 x 4,8 x 66,5 cm	10 x 69 x 5,5 cm	1,2 kg

BALKONSOCKEL

GRANIT 25

BALCONY BASE

GRANITE 25

Platzsparende Sockellösung für den Balkon mit Rollen.

Space-saving base solution with wheels for the balcony.

(Standrohr 48 mm, inkl. 3 Reduziereinsätze 25, 32, 38 mm)

(Pole 48 mm, incl. 3 adapters in 25, 32, 38 mm respectively)

Artikelnummer Item number	Größe Size	Verpackung Packaging	Gewicht Weight
85897KN25	55 × 25 × 7 cm	61 × 40 × 10 cm	~ 25 kg



~ 25 kg

BALKON - ROLLSOCKEL

STAHL 25

BALCONY - ROLLING BASE

STEEL 25

Schmaler Sockel mit vier Rollen für den Balkon aus pulverbeschichtetem Stahl, mit Edelstahlrohr und vier Rollen.

Narrow base with four wheels for the balcony. Made of powder-coated steel, with stainless steel tube and four wheels.

(Standrohr 48 mm, inkl. 3 Reduziereinsätze 25, 32, 38 mm)

(Pole 48 mm, incl. 3 adapters in 25, 32, 38 mm respectively)

Artikelnummer Item number	Größe Size	Verpackung Packaging	Gewicht Weight
85999KNPS25	50 × 25 × 8,5 cm	52 × 27 × 11 cm	~ 25 kg



~ 25 kg

ROLLSOCKEL

GRANIT 40 | GRANIT 50

ROLLING BASE

GRANITE 40 | GRANITE 50

Heller Granitsockel mit vier Rollen und Edelstahlrohr.

Light granite base with four wheels and stainless steel tube.

(Standrohr 60 mm, inkl. 4 Reduziereinsätze 32, 38, 48, 52 mm)

(Pole 60 mm, incl. 4 adapters in 32, 38, 48, 52 mm respectively)

Artikelnummer Item number	Größe Size	Verpackung Packaging	Gewicht Weight
85897KN40GG	48 × 48 × 7 cm	62 × 57 × 9 cm	ca. 40 kg
85897KN50GG	55 × 55 × 7 cm	70 × 64 × 9 cm	ca. 50 kg



~ 40 kg



~ 50 kg

SCHUTZHÜLLE

FÜR MITTELMASTSCHIRME

PROTECTIVE COVER

FOR CENTER POLE PARASOLS

Extra lange Schutzhülle für Mittelmastschirme aus witterungsbeständigem Polyester.

Extra long protective cover for center pole parasols made of weather-resistant polyester.

Artikelnummer Item number	Größe Size	Verpackung Packaging	Gewicht Weight
85399KN	32 × 180 cm	27 × 29 × 3 cm	0,6 kg







Schirmfarben von Imagebildern können wegen Lichteinstrahlung abweichen. | Abbildung ohne Windventil.
Canopy colors of image pictures can deviate due to light irradiation. | Image without air vent.

Knirps PENDULAR

Premium Sonnenschirme

Großartiges Design, hervorragende Funktionalität, maximaler Schatten: Die Knirps Pendular Schirme lassen keine Wünsche offen.

Alle Pendular Modelle sind leicht und bequem zu bedienen. Mit ein paar Handgriffen können die Schirme um **360 Grad** in verschiedene Positionen gedreht werden und das Schirmdach kann **geschwenkt und geneigt** werden, sodass unabhängig vom Sonnenstand immer genug Schatten gewährleistet ist.

Alle Knirps Pendular Schirme sind in Kombination mit ihren eleganten Ständern ein stilvolles Designelement für Garten und Terrasse mit maximalem Sonnenschutz.

Premium Parasols

Great design, excellent functionality, maximum shade: The Knirps Pendular parasols leave nothing to be desired.

All Pendular models are lightweight and easy to use. With a few simple steps, the parasol can be rotated **360 degrees** in various positions and the canopy can be **pivoted and tilted**, ensuring enough shade regardless of the position of the sun.

All Knirps Pendular parasols, combined with their elegant stands, are a stylish design element for garden and terrace with maximum sun protection.

OVERVIEW PENDULAR



MASTENDE POLE TIP

Aluminium-Mastende
mit Knirps-Logo
Aluminum pole tip with
Knirps logo



STUFENLOS NEIGBAR CONTINUOUSLY ADJUSTABLE



SCHWENKBAR SWIVELING

müheles nach beiden
Seiten schwenkbar
Effortlessly swivels to
both sides.

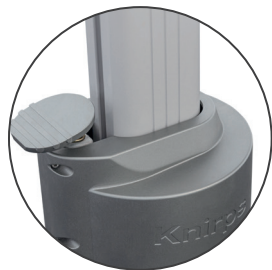

360° DREHBAR 360° ROTATABLE

KURBEL CRANK

Leichtgängige Kurbel mit
abklappbarem Griff
Smooth-running crank
with fold-down handle

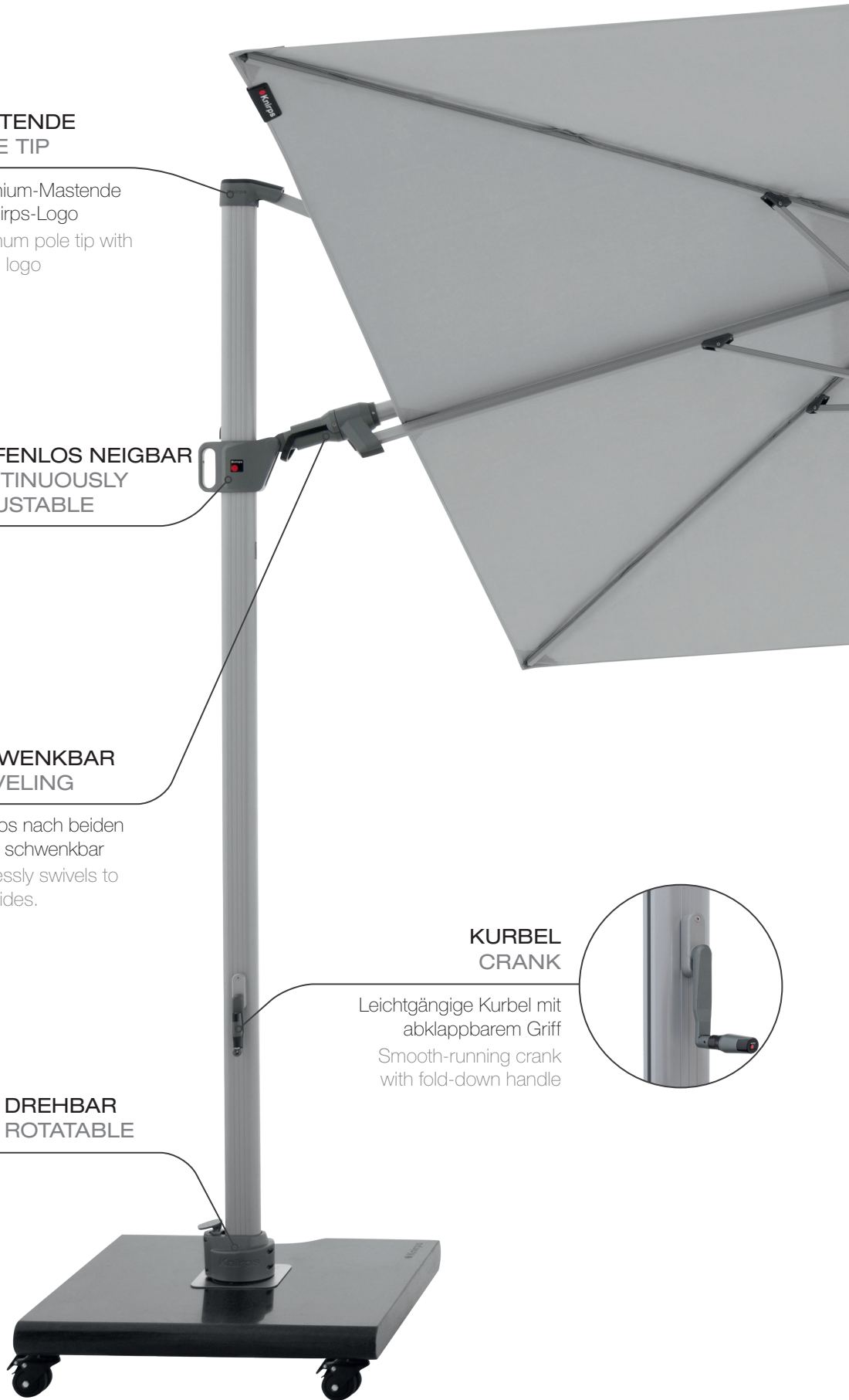

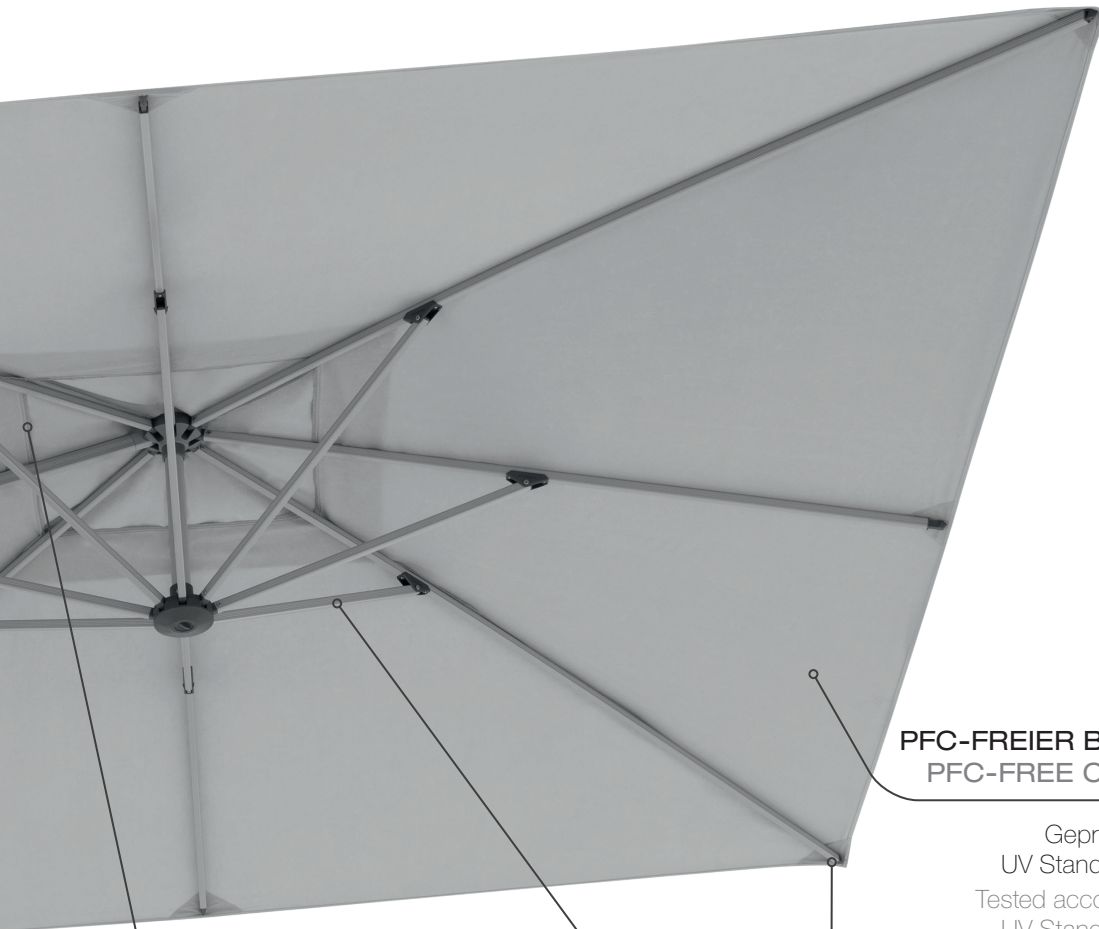

PFC-FREIER BEZUG
PFC-FREE COVER

Geprüft nach
UV Standard 801
Tested according to
UV Standard 801

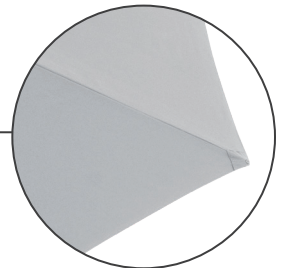

ABNEHMBARER BEZUG
REMOVABLE COVER

mit selbstspannende Spitzen
with Self-tensioning tips



WINDVENTIL
AIR VENT

verhindert Flattern des
Sonnenschirms bei Wind
prevents parasol flapping
in windy conditions

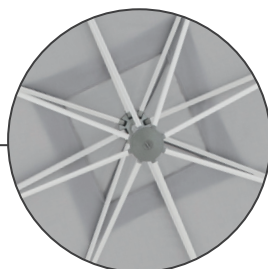

GESTELL
FRAME

Stabile Konstruktion
aus Aluminium
Robust aluminum
construction

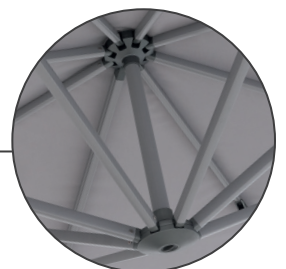



Schirmfarben von Imagebildern können wegen Lichteinstrahlung abweichen. | Abbildung ohne Windventil.
 Canopy colors of image pictures can deviate due to light irradiation. | Image without air vent.

5
YEARS

WARRANTY



PFC FREE



320 x 320 cm



REPELLANT



AIR VENT



LIGHTFAST



220 g/m²

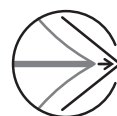

TENSIONER



REMOVABLE

Knirps PENDULAR 320 x 320



Modell Model	Artikelnummer Item number	Größe Size	Schirmfläche Parasol size	Rohr Ø Rod Ø	Verpackung Packaging	Gewicht Weight
Pendular 320 x 320/8	467244DP + Col.Nr.	320 x 320 cm	ca. 10,24 m ²	98 x 60 mm	288 x 50 x 19 cm	42,9 kg
Schutzhülle	85399KNP340	55 x 234 cm			53 x 33 x 5 cm	2 kg

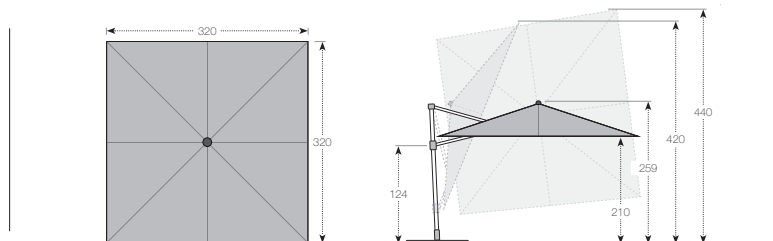



Schirmfarben von Imagebildern können wegen Lichteinstrahlung abweichen. | Abbildung ohne Windventil.
 Canopy colors of image pictures can deviate due to light irradiation. | Image without air vent.

5
YEARS

WARRANTY



PFC FREE



275 x 275 cm



REPELLANT



AIR VENT



LIGHTFAST



220 g/m²

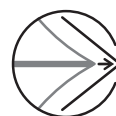

TENSIONER



REMOVABLE

Knirps PENDULAR 275 x 275

- 
 12
 DARK GREY
- 
 13
 LIGHT GREY
- 
 07
 WHITE
- 
 06
 BORDEAUX
- 
 040
 NATURE



gardiente
 OUTDOOR
 LIVING
 AWARD
 WINNER
 2018
SILVER



140kg

Modell Model	Artikelnummer Item number	Größe Size	Schirmfläche Parasol size	Rohr Ø Rod Ø	Verpackung Packaging	Gewicht Weight
Pendular 275 x 275/8	483244DP + Col.Nr.	275 x 275 cm	ca. 7,56 m ²	50 x 80 mm	264 x 44 x 16 cm	29,6 kg
Schutzhülle	85399KNP275x275	54 x 212 cm			54 x 34 x 3 cm	2,1 kg

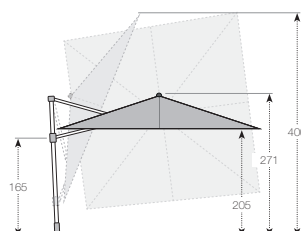
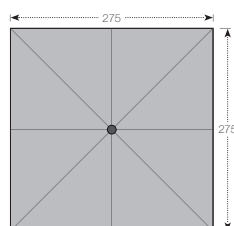



Schirmfarben von Imagebildern können wegen Lichteinstrahlung abweichen. | Abbildung ohne Windventil.
 Canopy colors of image pictures can deviate due to light irradiation. | Image without air vent.

5
YEARS

WARRANTY



PFC FREE



275 x 275 cm



REPELLANT



AIR VENT



LIGHTFAST



220 g/m²

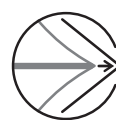

TENSIONER



REMOVABLE

Knirps PENDULAR 340



140kg



Modell Model	Artikelnummer Item number	Größe Size	Schirmfläche Parasol size	Rohr Ø Rod Ø	Verpackung Packaging	Gewicht Weight
Pendular 340/8.	438244DP + Col.Nr.	340 cm	ca. 9,07 m ²	50 x 80 mm	292 x 44 x 17 cm	30,5 kg
Schutzhülle	85399KNP340	55 x 234 cm			53 x 33 x 5 cm	2 kg

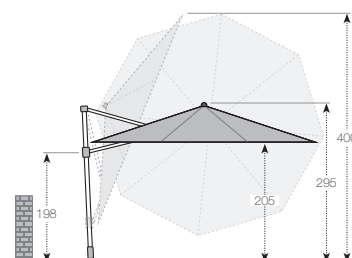
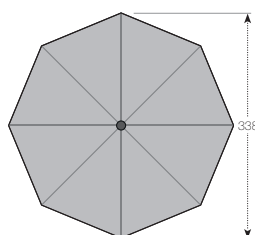

ADD-ONS PENDULAR



~140kg



ROLLSOCKEL

GRANIT 140

ROLLING BASE

GRANITE 140

Edler Sockel mit elegantem Edelstahlgriff aus poliertem, dunklen Granit mit vier leichtläufigen Rollen.

Elegant base with dark, polished granite, four smooth-rolling wheels, and an elegant stainless-steel handle.

für Pendular 275 × 275 | 340

for Pendular 275 × 275 | 340

Artikelnummer Item number	Größe Size	Verpackung Packaging	Gewicht Weight
85897KNR140	80 × 80 × 11,5 cm	85 × 85 × 28 cm	~ 140 kg



BODENANKER

FÜR KNIRPS PENDELSCHIRME

GROUND ANCHOR

FOR KNIRPS PENDULAR

Verzinkter und pulverbeschichteter Bodenanker zur dauerhaften Platzierung Ihres Pendelschirms.

Galvanized and powder-coated ground anchor for permanent placement of your side pole parasol.

für Pendular 275 × 275 | 320 × 320 | 340

for Pendular 275 × 275 | 320 × 320 | 340

Artikelnummer Item number	Größe Size	Verpackung Packaging	Gewicht Weight
85999KNBR105150	16 × 16 × 50 cm	51 × 17 × 17 cm	3,6 kg

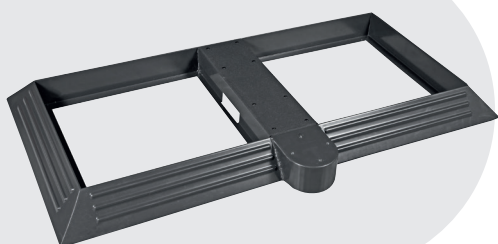

RAHMENSTÄNDER

STAHL FÜR PENDULAR 275 × 275 | 340

FRAME STAND

STEEL FOR PENDULAR 275 × 275 | 340

Platzsparender, verzinkter und pulverbeschichteter Metallrahmenständer geeignet für Platzierung an der Wand. Der Ständer muss mit zwei 50 × 50 cm Platten beschwert werden. Schirm darf bei dieser Variante lediglich um 180° Grad gedreht werden.

Space-saving, galvanized, and powder-coated metal frame stand suitable for wall placement. The stand must be weighted down with two 50 × 50 cm plates. The parasol can only be rotated 180° in this variant.

Artikelnr. Item nr.	Größe Size	Verpackung Packaging	Gewicht Weight
85999KNRS	134 × 68(79) × 9 cm	137 × 83 cm × 17 cm	16,3 kg

RAHMENSTÄNDER

STAHL 200

FRAME STAND

STEEL 200

Pulverbeschichteter Metallrahmenständer für vier 50 x 50 cm Platten.

Powder-coated metal frame stand for four 50 x 50 cm plates.

für Pendular 320 x 320

for Pendular 320 x 320

Artikelnummer Item number	Größe Size	Verpackung Packaging	Gewicht Weight
85999KNRS320Q	112 x 112 x 21 cm	120 x 120 x 23 cm	19,9 kg



ABDECKPLATTE

FÜR RAHMENSTÄNDER STAHL 200

COVER PLATE

FOR FRAME STAND STEEL 200

Die pulverbeschichtete Metallabdeckung verdeckt die vier Beschwerplatten des Rahmenständers.

The powder-coated metal cover conceals the four weight plates of the frame stand.

Artikelnummer Item number	Größe Size	Verpackung Packaging	Gewicht Weight
85999KNABRS	108 x 108 x 6 cm	111 x 111 x 7 cm	24,1 kg

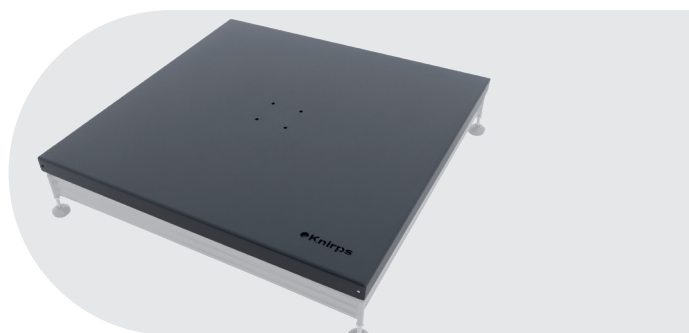

RÄDERSET

FÜR RAHMENSTÄNDER STAHL 200

WHEEL SET

FOR FRAME STAND STEEL 200

Nachrüstset bestehend aus vier Rädern für den Stahlrahmenständer.

Upgrade kit consisting of four wheels for the steel frame stand.

Artikelnummer Item number	Größe Size	VE PU	Gewicht Weight
85999KNRS320QR	26 x 24 x 8 cm	1	2,4 kg



PROTECTOR

FÜR PENDELSCHIRME

PROTECTOR

FOR SIDE POLE PARASOLS

Witterungsbeständige Schutzhülle für Pendelschirme aus robustem Polyester.

Weather-resistant protective cover for side pole parasols made of robust polyester.

85399KNP340 für Pendular 320 x 320 und 340

85399KNP275x275 für Pendular 275 x 275

85399KNP340 for Pendular 320 x 320 und 340

85399KNP275x275 for Pendular 275 x 275

Artikelnummer Item number	Größe Size	Verpackung Packaging	Gewicht Weight
85399KNP340	55 x 234 cm	53 x 33 x 5 cm	2 kg
85399KNP275x275	54 x 212 cm	54 x 34 x 3 cm	2,1 kg

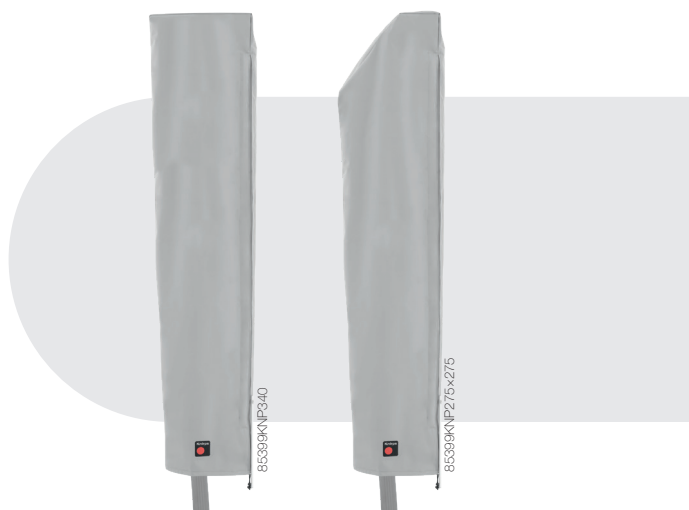





Schirmfarben von Imagebildern können wegen Lichterstrahlung abweichen.
Canopy colors of image pictures can deviate due to light irradiation.

POINT OF SALE

Das variable Shop in Shop System lässt sich flexibel für Knirps Apoll als auch Knirps Phoenix Modelle kombinieren: Stehle mit attraktivem Image, Präsentationsdisplay Schirme mit oder ohne Infobox sowie das Standing Rack geeignet für Apoll, sorgen für eine professionelle Produktpräsentation.

The variable Shop in Shop system can be flexibly combined for both Knirps Apoll and Knirps Phoenix models: a stand with an attractive image, presentation display parasols with or without an info box, and the standing rack suitable for Apoll provide a professional product presentation.

Knirps POINT OF SALE



Knirps SCHIRM-PRÄSENTER Knirps PARASOL DISPLAY CASE

Das Shopmodul präsentiert bis zu fünf Mittelmastschirme und kann mit der Infobox kombiniert werden.

The shop module presents up to five center pole parasols and can be combined with the info box.

Artikelnr. Item number	Größe Size	Verpackung Packaging
86199KNPR	40 x 162 x 270 cm	170 x 45 x 30 cm



Knirps BANNER-AUFSTELLER Knirps STAND-UP BANNER DISPLAY

Kederdisplay als Blickfang am POS mit praktischem Prospekthalter und Hängevorrichtung für Stoffflaschen oder Schutzhülle.

Keder display as an eye-catcher at the POS with a practical brochure holder and hanging device for fabric loops or protective covers.

Artikelnr. Item number	Größe Size	Verpackung Packaging
86199KNBA	40 x 70 x 270 cm	150 x 80 x 20 cm



Knirps TEPPICH Knirps CARPET

Knirps Teppich zur Produktpräsentation: Drei Varianten für das Shopmodul und einzelne Schirmpräsentation erhältlich.

Knirps carpet for product presentation: three variants available for the shop module and individual parasol presentation.

Artikelnummer Item number	Größe Size	Verpackung Packaging
86199KNTKU	85 x 270 cm	110 x 130 x 80 cm
86199KNTLA	85 x 440 cm	110 x 130 x 80 cm
86199KNT	100 x 100 cm	100 x 11 x 80 cm

Knirps STANDING RACK APOLL

Praktisches Knirps POS-Display mit Knirps Infobox aus schwarz lackiertem Metall, für 12 Knirps Mittelmastschirme.

Practical Knirps POS display with black lacquered metal Knirps info box, for 12 Knirps center pole parasols.

Artikelnr. Item number	Größe Size	Verpackung Packaging
86199KNSTR	80 × 120 × 266 cm	81 × 14 × 172 cm



Knirps INFOBOX APOLL

Informationsbox zu Knirps Apoll Schirme aus schwarz lackiertem Metall kombinierbar mit Standing Rack, Schirm-Präsentier oder einzeln platzierbar im Knirps Sockel.

Information box for Knirps Apoll parasols made of black lacquered metal can be combined with standing rack, parasol presenter, or placed individually in the Knirps base.

Artikelnr. Item number	Größe Size	Verpackung Packaging
86199KNINF	23 × 23 × 189 cm	25 × 25 × 180 cm



Zwei 5er-Knirps-Warenträger mit Banneraufsteller auf Knirps Teppich lang
Two 5s Knirps wares carrier with banner display on Knirps carpet long



Knirps POINT OF SALE

Die modularen Knirps Shop-in-Shop-Konzepte sind speziell auf Verkaufsflächen von sechs, neun oder zwölf Quadratmetern zugeschnitten, um die maximale Nutzung der Fläche zu gewährleisten und eine professionelle Präsentation unserer Produkte zu ermöglichen.

Knirps' modular Shop in Shop concepts are designed to make optimal use of retail space and professionally showcase products. Available in six, nine, or twelve square meter configurations, these concepts are tailored to fit a variety of needs.

SHOP-IN-SHOP CONCEPT L

für 12m² | for 12 m²



L – 12 m²



Artikelnummer Item number	Artikelbezeichnung Product name	Größe Size	Verpackung Packaging
	Knirps Apoll nach Wahl		
86199KNPR	Knirps Schirm-Präsentier	40 x 162 x 270 cm	170 x 45 x 30 cm
86199KNSTR	Knirps Standing Rack	80 x 120 x 266 cm	81 x 14 x 172 cm
86199KNBA	Knirps Banner-Aufsteller	40 x 70 x 270 cm	150 x 80 x 20 cm
86199KNTLA	Knirps Teppich (optional)	85 x 440 cm	110 x 130 x 80 cm

SHOP-IN-SHOP CONCEPT M

für 9 m² | for 9 m²



M – 9 m²



Artikelnummer Item number	Artikelbezeichnung Product name	Größe Size	Verpackung Packaging
	Knirps Apoll nach Wahl		
86199KNPR	Knirps Schirm-Präsentier	40 × 162 × 270 cm	170 × 45 × 30 cm
86199KNINF	Knirps Infobox	23 × 23 × 189 cm	25 × 25 × 180 cm
86199KNBA	Knirps Banner-Aufsteller (optional)	40 × 70 × 270 cm	150 × 80 × 20 cm





Schirmfarben von Imagebildern können wegen Lichteinstrahlung abweichen.
Canopy colors of image pictures can deviate due to light irradiation.

Knirps ICONS



WARRANTY

Wir gewährleisten **5-Jahre-Garantie** für alle Knirps Produkte.
We guarantee a **5-year warranty** for all Knirps products.



Der höchste **UV-Schutz 80** wird im unabhängigen Institut Hohenstein nach **Standard 801** garantiert.

The highest **UV protection 80** is guaranteed by the independent institute Hohenstein according to **standard 801**.



LIGHTFAST

Alle Knirps Sonnenschirme weisen eine sehr gute **Lichtechtheit** von 6-7 auf.

All Knirps parasols have a very good **lightfastness** of 6 - 7.



Bezug ist aus **recyceltem Polyester** hergestellt.
Canopy is made of **recycled polyester**.



Der **abnehmbare Bezug** lässt sich leicht vom Gestell entfernen.
The **removeable canopy** can easily be taken of the frame.



REPELLANT

Die Bezüge sind PFC-frei **Wasser- und Schmutzabweisend** ausgerüstet.

The covers are PFC-free and treated with **water and dirt repellent**.



XXX g/m²

Die witterungsbeständigen **Polyestergewebe sind 220g/m² schwer**.

The weather-resistant **polyester fabrics weigh 220g/m²**.



50 kg

Das angegebene **Mindestgewicht** sorgt für einen stabilen Stand des Sonnenschirms.

The specified **minimum weight** ensures a stable base for the parasol.



AR VIEW

Scannen Sie den QR-Code mit dem Smartphone oder Tablet, um die **AR-Funktion** zu starten und den Schirm in Ihrer Umgebung zu sehen.

Scan the QR code with your smartphone or tablet to start the **AR function** and see the parasol in your surroundings.

MAXIMALER SCHATTEN ZU JEDER TAGESZEIT

Die Mittelmast-Modelle von Knirps sind eine ideale Lösung für Balkone und Terrassen, da sie eine praktische Höhenverstellung von bis zu 30 cm bieten. Zusammen mit der automatischen Knickfunktion bieten die Schirme auch bei tiefem Sonnenstand immer optimalen Schatten.

Unsere Pendelschirmmodelle bieten maximale und flexible Beschattung von bis zu 10 m² zu jeder Tageszeit, da sie um 360° drehbar sind und das Schirmdach schrägstellbar ist. Zudem bieten sie die einzigartige Möglichkeit der axialen Neigung. Alle Knirps Sonnenschirme haben einen UV-Schutz von 80 (nach Standard 801).

MAXIMUM SHADE AT ANY TIME OF DAY

Knirps center pole models are an ideal solution for balconies and terraces, as they offer a practical height adjustment of up to 30 cm. Together with the automatic tilt function, the parasol always provide optimal shade even when the sun is low.

Our side pole parasol models offer maximum and flexible shading of up to 10 m² at any time of the day, as they can be rotated 360 degrees and the canopy can be tilted.

They also offer the unique possibility of axial inclination. All Knirps parasols have a UV protection of 80 (according to standard 801).

MITTELMAST SCHIRME CENTER POLE PARASOLS

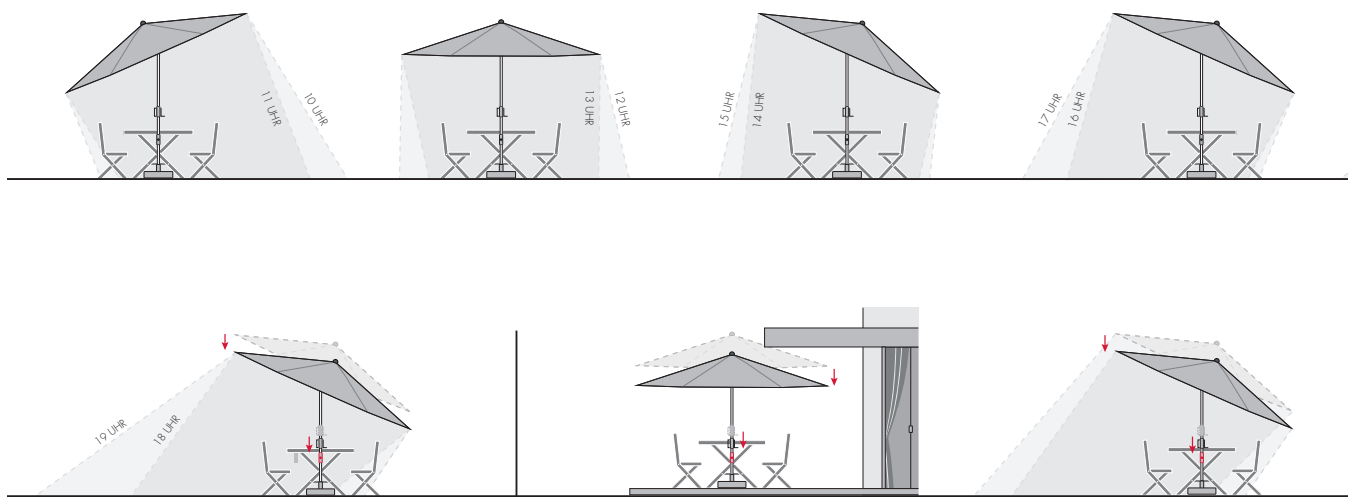

PENEDLSCHIRME SIDE POLE PARASOLS

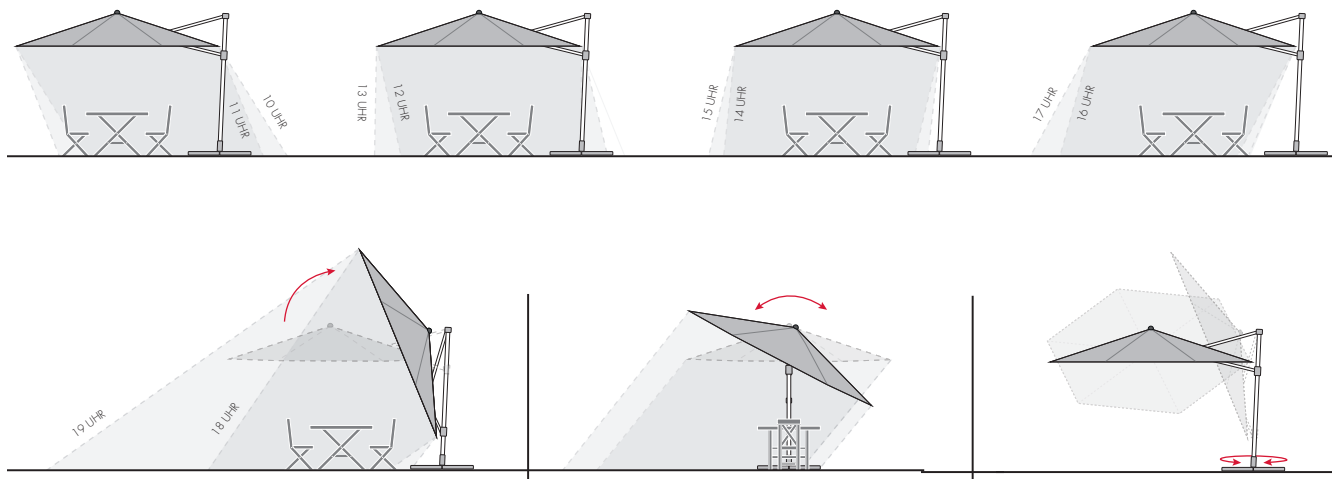

knirps.com

Deutschland
doppler H. Würlingsdobler GmbH
knirps@dopplerschirme.com
Tel.: +49 (0) 8571 91 22 314
Fax: +49 (0) 8571 91 22 300
A.-Kolping-Str. 3
84359 Simbach am Inn

Österreich
doppler E. Doppler & Co GmbH
knirps@dopplerschirme.com
Tel.: +43 (0) 7722 63205 109
Fax: +43 (0) 7722 66918
Schloßstraße 24
5280 Braunau am Inn

International
doppler E. Doppler & Co GmbH
knirps@dopplerschirme.com
Tel.: +43 (0) 7722 63205 107
Fax: +43 (0) 7722 66918
Schloßstraße 24
5280 Braunau am Inn

